



Leland Legacy Sample Pump
Cat. No. 100-3002
Operating Instructions



Figure 1. Leland Legacy Sample Pump

TABLE OF CONTENTS

Introduction..... 3

 Description..... 3

 Checking Kit Contents 3

 Required Equipment..... 3

Getting Started 4

 Charge the Battery Pack 4

 Reading Charging Status LED on the Single Charger..... 4

 Determining Battery Charge Status 4

Notes and Cautions 5

Using the Keypad 5

 Turning Pump Power On/Off 6

Setting Up the Pump 6

Entering and Navigating Setup	6
Setup Options	6
Setup Functions	7
Operation.....	10
Set/Calibrate Flow Rate (Manual Calibration)	10
Set/Calibrate Flow Rate (CalChek Single Calibration)	11
Set Up/Sample	13
Sampling Functions	13
Program the Pump Using a PC	14
Maintenance.....	15
Notes and Cautions	15
Change the Battery Pack.....	15
Full Calibration (Multiple-point) Using CalChek.....	16
CalChek Full Calibration Data (Requires DataTrac for Leland Legacy Software)	17
CalChek Full Calibration Data Verification (Requires DataTrac for Leland Legacy Software).....	17
Troubleshooting	18
CalChek Error Chart.....	18
Single-point Calibration Errors.....	18
Multiple-point (Full) Calibration Errors	18
Errors That Can Occur During Both Calibration Modes.....	18
Accessories/Replacement Parts	19
Accessories	19
Replacement Parts	20
Appendix: Performance Profile	21

INTRODUCTION

Description

The Leland Legacy® dual diaphragm sample pump (*Figure 1*) is designed specifically to provide constant airflows from 5 to 15 L/min with minimum power requirements and low noise. *The Leland Legacy is not for applications requiring intrinsic safety or high back pressures.*

Checking Kit Contents

Use the table below to verify that you received all items associated with the Cat. No. ordered. If you are missing items, contact SKC at 800-752-8472 (U.S. only) or 724-941-9701.

If You Ordered Cat. No.	Your Package Should Contain
100-3002	Leland Legacy Pump with lithium-ion (Li-Ion) battery and screwdriver set
100-3002K	Single Pump Kit includes pump with high-power Li-Ion battery, 100-240 V single charger, in a Pelican case
100-3002K5	5-pack Pump Kit includes 5 pumps, Take Charge 5 Multi-charger, and DataTrac Software Cable for Leland Legacy (<i>software available via free download from www.skcinc.com</i>), in a Pelican case

Required Equipment

- ✓ 3/8-inch ID (1/2-inch OD) Tygon® tubing
- ✓ Charger for Li-Ion battery-powered pump

GETTING STARTED

Charge the Battery Pack

Completely charge the battery pack before operating the pump. It may be necessary to charge the battery a few times before maximum capacity is achieved. For a complete charge, ensure the pump is not running during charging. **Note:** Shown with single charger Cat. No. 223-241. A five-station charger is available; see Accessories. Follow charger instructions.

1. Insert the plug on the charging unit into the battery charging jack on top of the pump (underneath the protective cover).
2. Insert the plug on the power supply into the jack on the charging unit.
3. Slide the appropriate wall plug into the power supply and plug the power supply into a wall outlet. The battery will recharge in approximately 15 hours.

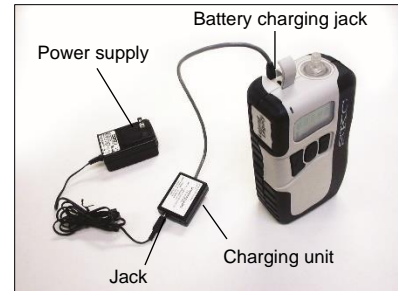

Leland Legacy charging train with single charger

Reading Charging Status LED on the Single Charger

The Li-Ion Charging Unit Cat. No. P22300 indicates battery charge status via an LED on the unit that blinks in specific patterns. Observe the LED steadily for > 5 seconds to read charge status.

LED Action				Charge Status
ON * steady				Charge in progress
ON * 2 sec	OFF ○ .25 sec	ON * 2 sec	(Repeats)	Approximately 80% charged
OFF ○ 2 sec	ON * .25 sec	OFF ○ 2 sec	(Repeats)	Charge completed

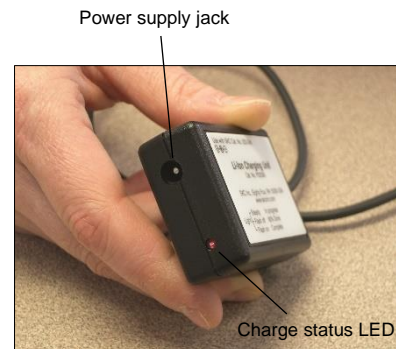

Determining Battery Charge Status



Three bars indicate a full charge (normally appears after charging), approximately 75 to 100%.



Two bars indicate that the battery is charged enough to operate the pump, approximately 25 to 75%. One bar indicates battery charge is low (charge battery), approximately 1 to 25%.



No bars and a flashing outline indicate a Low Battery Fault mode (pump will go into Hold).



No bars and a flashing outline indicate a low battery fault mode (pump will go into Hold)

Notes and Cautions

- Use only the SKC-approved charger for this pump. Use of an unapproved charger may damage the battery and pump and VOID ANY WARRANTY.
- Using a repaired or rebuilt battery pack VOIDS ANY WARRANTY.
- Do not charge or operate pump with or without the charger in hazardous locations.
- Ensure proper orientation of charging cable before plugging it into the charging jack. Improper orientation/contact will short circuit the battery and VOID ANY WARRANTY.
- Short circuiting the battery pack will render it immediately inoperative.
- After charging the battery pack, it is good practice to run the pump for approximately five minutes before calibrating. This ensures the battery is in more steady-state conditions and improves the agreement in pre and post-sampling calibrations.
- The battery pack may be kept on the SKC-approved Li-Ion battery charger for an indefinite time.
- Tampering with the battery pack VOIDS ANY WARRANTY.
- Do not open, disassemble, short circuit, crush, incinerate, or expose the battery to fire or temperatures in excess of 212 F (100 C).
- Failure to follow warnings and cautions voids any warranty.

For more information on pump battery packs, go to www.skcinc.com/knowledgecenter.

Using the Keypad

The Leland Legacy pump is operated by pressing key sequences on the keypad located on the front of the pump case. See below.

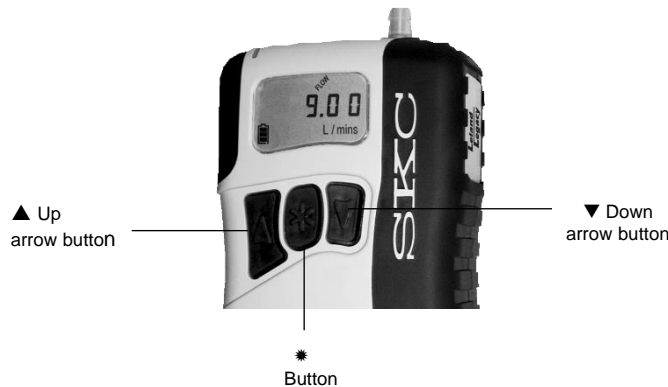

Key	Action
*	Scrolls through run time data and Setup options
▲	Increases values such as flow rate
▼	Decreases values such as flow rate

Key Sequence	Action/Result
[▲▼]	When pressed simultaneously, displayed item is selected or entered.
▲▼	Security code that must be pressed in sequence to enter Setup

Turning Pump Power On/Off

- Press any button to turn on the power.
- Press [▲▼] to run the pump or to place a running pump in Hold.
- Manual Off: from Hold, press and hold *.
- Auto Off turns off the pump after five minutes in Hold.

Setting Up the Pump

Entering and Navigating Setup

Enter: Press [▲▼], then press the security code *▲▼* in sequence. Setup should appear briefly on the LCD.



Navigate: Press * to scroll through parameters or options. Once the LCD shows End, parameters will repeat until the user exits Setup.

Exit: Press * until End appears on the LCD. Press [▲▼]. The pump is now in Hold.

Setup Options

After entering Setup, go to:

1. **Flow Set:** Press ▲ or ▼ to increase or decrease pump flow rate. Pump will start running. Press * to move to next parameter.
2. **ADJ:** Used during calibration with calibrator (**not for use with CalChek feature**). Press ▲ or ▼ to increase or decrease flow adjustment until desired flow is indicated on calibrator. Press * until End appears. Press [▲▼] to save new flow and adjustment settings and exit Setup. **Note:** If changing other parameters, do not press [▲▼] but continue pressing * after End appears and the remainder of the menu items will appear. Once all changes are entered, press * until End appears, then press [▲▼] to save new settings and exit Setup. Pressing [▲▼] when Esc appears will exit Setup without saving new settings.
3. **CALCh:** Use for CalChek calibration feature only. Pressing [▲▼] initiates single-point calibration. Pressing ▲ seven times initiates a full calibration. See CalChek Calibration instructions in Set/Calibrate Flow Rate (CalChek Single-point Calibration) or Full Calibration (Multiple Point) Using CalChek.
4. **12 Hr/24 Hr Clock and Delayed Start (factory default is 12 Hr clock):** Press ▲ or ▼ to move between standard (12 hour), military (24 hour), and Dela (delayed start). Press * to select. If Dela (delayed start) is selected, follow instructions in Set a Delayed Start.
5. **Time of day:** Press ▲ or ▼ to increase or decrease flashing hour. Press * to move from hours to minutes. Press or ▼ to increase or decrease flashing minutes. Press * to move to next parameter.
6. **ST (Sampling Time):** Allows the user to program a specific run time. Press ▲ or ▼ to increase or decrease the time in minutes (up to 99,999 minutes). Press * to move to next parameter. See Set and Delete a Sampling Time.

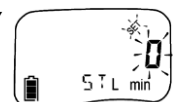
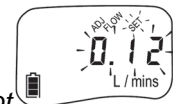
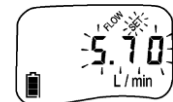

7. **Temperature (factory default is Celsius):** Press ▲ or ▼ to toggle between Fahrenheit (F) and Celsius (C). Press * to move to next parameter.



8. **Atmospheric Pressure (factory default is mm):** Press ▲ or ▼ to toggle between inches of mercury (In), millibars (mb), and millimeters of mercury (mm). Press * to move to next parameter.



9. **CLr:** Press [▲▼] to reset accumulated run time and volume data to zero. See *Reset Run Time Data*.



10. **ESC:** Press [▲▼] to exit Setup without saving new settings.



11. **End:** Press [▲▼] to save new settings and exit Setup.



PrOFF: Appears only when a program is loaded into pump memory. See *DataTrac for Leland Legacy Software Operating Instructions* for setting a program at www.skinc.com/knowledgecenter. See *Delete a DataTrac Program or Delayed Start*.

Setup Functions

Reset Run Time Data

To reset accumulated volume and run time data to zero:

1. Press [▲▼], then press the security code *▲▼* in sequence. Setup will display briefly.
2. Press * until CLr appears, then press [▲▼].
3. Press * until End appears, then press [▲▼] to exit Setup. The accumulated data is cleared and the pump is now in Hold.

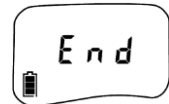
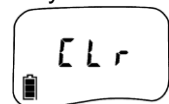

 **CLr does not clear previously set sampling time (ST). See *Delete a Sampling Time*.**

Set a Sampling Time (ST)

Program the pump from the integral keypad or a PC using DataTrac software to sample from 1 to 99,999 minutes.

1. Press [▲▼], then press the security code *▲▼* in sequence. Setup will display briefly.
2. Repeatedly press * until ST L/min and a flashing time and Set appear on the display.
3. Set the sampling time by pressing ▲ or ▼ to increase or decrease it to the desired time in minutes.
4. Press * repeatedly until End appears.
5. Press [▲▼] to save the new sampling time and exit Setup.



6. Press [▲▼] to begin sampling. The time display will count down in minutes and the pump will go to Hold. The total sampling time will display.
7. To delete a set sampling time, see *Delete a Sampling Time in Sampling Functions*.



Set a DataTrac Program

See *DataTrac for Leland Legacy Software Operating Instructions* at www.skinc.com/knowledgecenter.

Set a Delayed Start

A delayed start can be programmed using the pump keypad or from a PC using DataTrac Software. The following instructions are for keypad only. See *DataTrac for Leland Legacy Operating Instructions* at www.skinc.com/knowledgecenter for programming from a PC.



Display for delayed start



Once a program is set in the pump, the pump cannot be run manually. To return to manual pump operation, let the program run its course or delete the program. See *Delete a DataTrac Program or a Delayed Start*.

When setting the pump for sampling from 1 to 99,999 minutes to begin within the next 12-hour period, follow this procedure:

1. Press [▲▼], then press the security code *▲▼* in sequence. Setup will display briefly.
2. Press * until the display reaches the 12 Hr/24 Hr clock. If delayed start is already programmed, the display will show Dela (delayed start) in place of 12 Hr. If no delay is programmed, press ▲ or ▼ until the display shows a flashing Dela (delayed start).
3. Press * until the time of day (flashing hours) displays. Select the hour (time of day) that the pump is to begin sampling (within the next 12 hours) by pressing ▲ or ▼ until the desired hour displays. Press * and the minutes will flash. Press ▲ or ▼ until the desired minutes display.
Note: *The time of day entered will be the next occurrence of this time within the next 12-hour period after the delayed start is entered. There is no a.m. or p.m. designation.*
4. Press * until the ST displays. Press ▲ or ▼ to set the desired run time in minutes. **A delayed start cannot be run unless a sampling time (ST) is programmed.**
5. Press * until End appears.



6. Press [▲▼] to save settings and exit Setup.
7. Prog and a flashing Hold will appear in the upper left corner of the display. The pump is now set for delayed start.

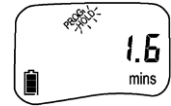

Set Pump Flow Rate

1. Press [▲▼], then press the security code *▲▼* in sequence.
2. The flow rate and Set will flash on the LCD. Press ▲ to increase flow rate. Press ▼ to decrease flow rate. The pump will run while flow is set.
3. Once the desired flow rate is displayed, press * until End appears on the display. The pump will stop running.
4. Press [▲▼] to save the new flow rate and exit Setup.

Flow Rate and Volume Display

- *Flow Rate* displayed on the pump LCD is the flow to which the pump has been calibrated. To maintain flow as displayed, the pump automatically adjusts flow during sampling for changes in temperature and atmospheric pressure* that may differ from the temperature and atmospheric pressure present at the time of calibration. The flow rate display does not change from the calibrated flow rate. The pump will fault if it is unable to maintain the calibrated flow rate.
- *Volume* displayed on the pump LCD is “corrected” in that it is the result of a continual calculation of corrected flow rate multiplied by sample time.

Volume does not display after 99,999 liters. See *Volume Display under Sampling Functions*.

* *The pump can apply correction to volumetric flow during sampling for weather-related or altitude variations from the atmospheric pressure established at calibration up to at least 7500 feet above and 5000 feet below sea level.*

OPERATION

Set/Calibrate Flow Rate (Manual Calibration)

- Allow pump to equilibrate after moving it from one temperature extreme to another.
 - Charge pump battery completely before calibration and sampling.
1. Ensure the pump has run for 5 minutes before performing calibration.
 2. Connect the pump inlet to a calibrator outlet with representative media in line.
Note: The High Flow chek-mate Calibrator with CalChek also requires Pulsation Dampener Cat. No. 375-150 in line between pump inlet and calibrator outlet (see Accessories). See Figure 2.
 3. Press [▲▼], then press the security code *▲▼* in sequence. The flow rate and Set will flash.
 4. Set the flow on the pump display by pressing ▲ or ▼ to increase or decrease flow to the desired rate.
 5. Press *. Adj will appear.
 6. If the calibrator reads a higher flow rate than the pump is set for, press ▼ until they agree (within 10 ml). If the calibrator reads a lower flow rate, press ▲ until they agree (within 10 ml). When pressing ▲ or ▼, the pump display will indicate the adjustment (or correction) made in L/min.
 7. Press * until End appears.
 8. Press [▲▼] to save new flow rate and Adj and exit Setup. Reset run time data. See *Reset Run Time Data in Sampling Functions*.

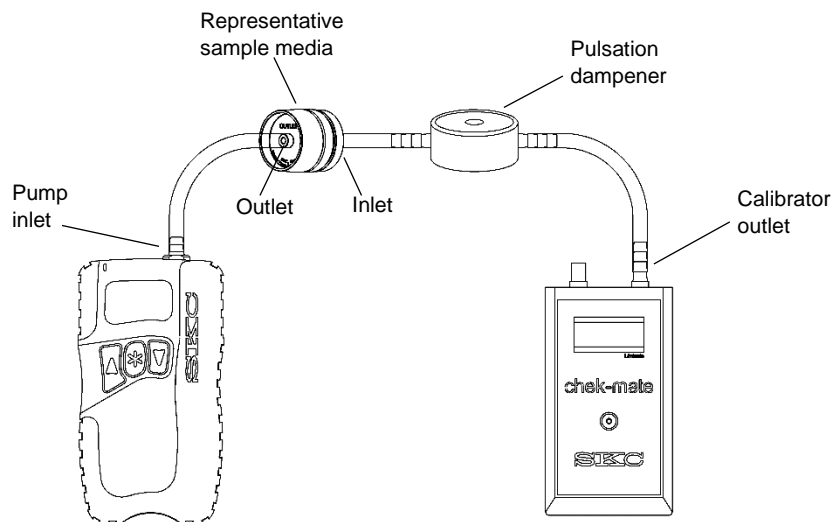
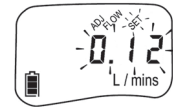
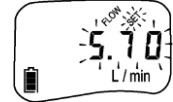

Figure 2. Calibration Train (Manual Calibration)



If the pump has been programmed with DataTrac Software and switched to manual operation, a program may remain in pump memory. Prog will display in the upper left corner of the pump display. See *Delete a DataTrac Program or a Delayed Start in Sampling Functions*.

Set/Calibrate Flow Rate (CalChek Single Calibration)

- Allow pump to equilibrate after moving it from one temperature extreme to another.
- For optimum accuracy, do not perform single-point calibration until the pump has remained at ambient temperature for several hours.
- Calibrate with representative sampling media in line. The High Flow chek-mate Calibrator with CalChek also requires Pulsation Dampener Cat. No. 375-150 in line (see Accessories). See chek-mate operating instructions at www.skcinc.com/knowledgecenter.
- The CalChek feature provides correction at a single flow setting and usually takes less than one minute to complete. Use it to set the desired flow rate before sampling and to verify flow after sampling.

The CalChek automatic calibration feature is available when calibrating a Leland Legacy pump with a calibrator with CalChek feature. The High Flow chek-mate Calibrator with CalChek requires CalChek Communication Cable Cat. No. 375-200 (see Accessories) for communication between the pump and the calibrator.

1. Ensure the pump has run for five minutes before starting calibration. Leave the pump on.
2. Turn on the calibrator.
3. Connect the CalChek Communication Cable to the calibrator and the pump.
 - a. Plug one connector end of cable into CalChek interface socket on calibrator.



- b. Plug other connector end of cable into data port on top of pump.



- Using flexible 3/8-inch ID tubing, connect the chek-mate outlet to the pump inlet with Pulsation Dampener Cat. No. 375-150 and representative sample medium in line. See Figure 3.
Note: If required by the sampler, use a calibration adapter.

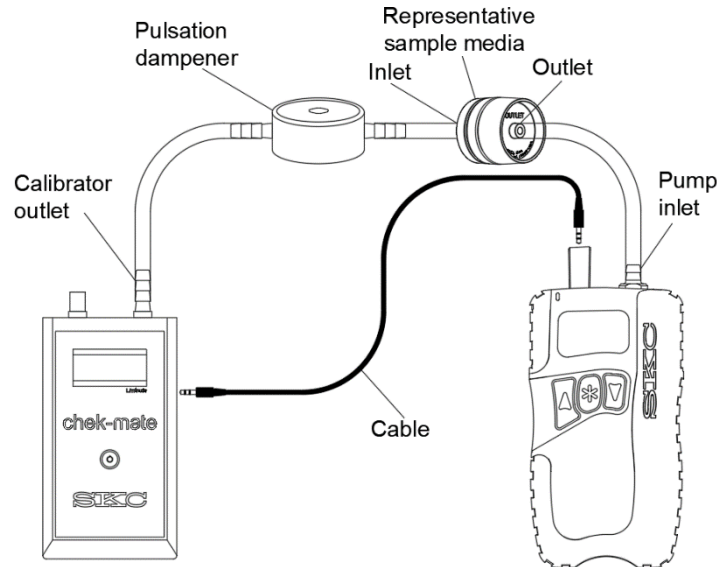
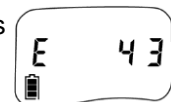



Figure 3. CalChek Single Calibration Train

- Press the security code *▲▼* in sequence on the pump keypad to enter Setup.
- Set the pump to the desired flow rate.
- Press * on the pump keypad until CALCh appears on the pump display. **Note:** If “no” is flashing on the pump LCD, the pump has not equilibrated. Wait until the “no” display disappears before proceeding with calibration.
- Press [▲▼] to initiate single-point calibration.
- When airflow through the chek-mate is detected, it will automatically produce its flow rate reading via the CalChek serial interface at 3.5-second intervals. The pump will display 1CAL. During calibration, the pump will **briefly** display the flow rates that it is reading from the calibrator.
- When calibration is completed, the pump will continue to run. If the calibration was successful, the pump LCD will revert to displaying pump run time as 0.0. If there was failure during the calibration process, an error code of E4[x] will appear (see *CalChek Error Chart in Troubleshooting*). **Note:** To remove a CalChek error code from the LCD, press *.
- Place the pump in Hold. Disconnect the pump, representative sampling medium, and pulsation dampener from the calibrator.
- Allow the pump to go to sleep.
- When ready to sample, proceed to *Set Up/Sample*.



-  **Successful single-point calibration will provide an entry in the pump history that can be viewed using DataTrac for Leland Legacy Software.**
-  **Allow pump to go to Sleep mode to write calibration data to pump history.**

Set Up/Sample

- Allow pump to equilibrate after moving it from one temperature extreme to another.
 - Charge pump battery completely before calibration and sampling.
 - Protect sample pump from weather when in use outdoors.
 - See functions available during sampling in *Sampling Functions*.
1. Following setup and calibration, replace representative sampling medium with a new unexposed sampling medium.
 2. To begin sampling, press [▲▼] to run the pump. Record the start time.
 3. Sample for the time specified in the method used.
 4. To stop sampling, press [▲▼] to place the pump in Hold. Record the stop time.
 5. When sampling is completed, pump data is retained in memory for recovery. Data can be viewed on the LCD by using the * button to scroll through it.



If the pump has been programmed with a PC, Prog will display in the upper left corner of the pump display. The pump will not operate manually. To restore manual operation, delete the program. See *Delete a DataTrac Program or Delayed Start in Sampling Functions* below.



Leland Legacy pump
with filter cassette in holder

Sampling Functions

Function	Action (Keypad or Other)
Scroll Through Data	Repeatedly press * to view run time or sample time (ST), sample volume, flow rate, temperature, atmospheric pressure, and time of day. <i>Note: If pump is started and stopped manually, pump LCD will count up run time and display cumulative run time at the end of sampling. If a sampling time (ST) has been programmed, pump will count down from the set time to zero, then display completed sampling time (ST).</i>
Reset Run Time Data	To reset accumulated volume and run time data to zero: 1. Press [▲▼], then press the security code *▲▼* in sequence. Setup will display briefly. 2. Press * until Clr appears, then press [▲▼]. <i>Note: CLR does not clear previously set sampling time (ST). See Delete a Sampling Time below.</i> 3. Press * until End appears, then press [▲▼] to exit Setup. The pump is now in Hold.
Delete a DataTrac Program or Delayed Start	1. Press [▲▼], then press the security code *▲▼* in sequence. Setup will display briefly. 2. Pressing *, scroll to the flashing PrOFF and press [▲▼]. 3. Press * until End displays. 4. Press [▲▼] to exit Setup. The PROG icon will disappear.



Function	Action (Keypad or Other)
Delete a Sampling Time (ST)	<ol style="list-style-type: none"> 1. Enter Setup and use the * button to scroll to ST L/min. Press ▼ until 0 displays. Press * until End appears. 2. Press [▲▼] to exit Setup. Note: A time still appears on the display after deleting a sample time. This value is cumulative run time since data was last cleared. To clear this display, see Reset Run Time Data above.
<p>Flow Fault</p> <p>If pump is unable to compensate for longer than 15 seconds due to excessive back pressure, a flow fault icon displays and flashes, pump enters Hold mode, and pump retains historical data. Pump will attempt to restart in 20 seconds (default setting) and try to continue sampling. If flow remains restricted, pump returns to flow fault. Auto-restart is attempted every 20 seconds up to 10 times (default setting). Flow fault time is not added to the displayed run time or cumulative volume display.</p>	<p>To clear a flow fault icon from the pump display after flow is restored, press [▲▼].</p> <p>Use DataTrac for Leland Legacy Software to adjust the amount of time the pump will remain in flow fault before going to Hold (5 to 30 seconds) and the number of auto-restart attempts (0 to 25).</p> <p>See DataTrac for Leland Legacy Software Operating Instructions at www.skcinc.com/knowledgecenter</p> 
<p>Volume Display</p> <p>When sampled volume exceeds 99,999 liters, an O_FIO Error will appear on the pump's LCD. Pump will continue to run normally and update volume beyond 99,999 liters.</p>	<p>To determine accumulated volume beyond 99,999 liters, go to the Real Time Monitor in DataTrac for Leland Legacy Software, or calculate volume by multiplying flow rate by the cumulative run time shown on the pump LCD. To clear the O_FIO display from the pump, reset the run time data. See Reset Run Time Data above.</p>

Program the Pump Using a PC

The Leland Legacy can be programmed manually with its integral keypad or by using a PC and DataTrac for Leland Legacy Software for full programmability. **Note:** For complete information on programming the Leland Legacy Pump using DataTrac for Leland Legacy Software, consult the DataTrac Operating Instructions at www.skcinc.com/knowledgecenter.

Install DataTrac Software onto a PC and connect the PC to the pump data port with the provided USB cable. With DataTrac, you can:

- Create and save a Leland Legacy run schedule in pump memory for use in the field later.
- Program a sampling strategy of up to 26 sampling sequences and flow rates.
- Program a delayed start or timed shutdown or perform STEL and replicate samples.
- Create a sample and analysis sheet for all critical information.
- Print or save to a PC file a complete history of run time data.
- Create a worker exposure profile containing sample and analysis information along with the pump's history, then import this into a text document.
- Document CalChek pump calibration.

MAINTENANCE

Notes and Cautions

- Do NOT place sampling media in line for full calibration.
- Ensure the battery pack is completely charged before starting a full calibration.
- Allow pump to equilibrate after moving it from one temperature extreme to another.
- For optimum accuracy, do not perform full calibration until the pump has remained at ambient temperature for several hours.
- SKC recommends that a full calibration be performed during pump maintenance and after non-factory repairs.
- Place Pulsation Dampener Cat. No. 375-150 in line for standard and CalChek calibrations with High Flow chek-mate Calibrator with CalChek (see *Accessories*).

Change the Battery Pack

- *To retain history, ensure the pump has been allowed to go to Sleep after the last run.*
- *Turn off the pump before removing the battery pack. Removing the battery pack while the pump is on or running may corrupt pump history.*
- *Programs should be reloaded using DataTrac for Leland Legacy Software after replacing the battery pack.*
- *Sampling time, delayed start, and other settings entered using the pump keypad should be reprogrammed after replacing the battery pack.*

1. Position pump with belt clip facing upward.
2. Use a Phillips head screwdriver to remove three screws on bottom half of pump.



3. Grasp and remove battery pack by pulling it up and away from pump body.



4. Align connector of new battery pack with connector in pump body.



5. Gently press new battery pack into pump body until it is flush with the pump case and replace the three screws.

 **Ensure that the long screw is replaced in the top screw hole. Do not overtighten screws.**

For more information on SKC pump battery packs, go to www.skcinc.com/knowledgecenter.

Full Calibration (Multiple-point) Using CalChek

- Do **not** place sampling media in line for full calibration. **Do** place Pulsation Dampener Cat. No. 375-150 in line when using High Flow chek-mate Calibrator (see Accessories).
- Allow pump to equilibrate after moving it from one temperature extreme to another.
- For optimum accuracy, do not perform full calibration until the pump has remained at ambient temperature for several hours.
- Ensure that battery is completely charged before starting full calibration.

This type of calibration using a calibrator with CalChek feature like the High-flow chek-mate Calibrator with CalChek (see Accessories) provides flow correction across the complete operating range of the Leland Legacy pump (5 to 15 L/min). The operation calibrates each flow rate to a calibrator. It can also provide a record of calibration for maintenance and quality purposes if DataTrac for Leland Legacy Software is used.

1. Ensure the pump has run for five minutes before starting calibration. Leave the pump on.
2. Turn on calibrator.
3. Install Communication Cable Cat. No. 375-200 between the pump and calibrator. See Step 3 in Set/Calibrate Flow Rate (CalChek Single Calibration).
4. Using flexible 3/8-inch ID tubing, connect the chek-mate outlet to the pump inlet with Pulsation Dampener Cat. No. 375-150 in line. See Figure 4.

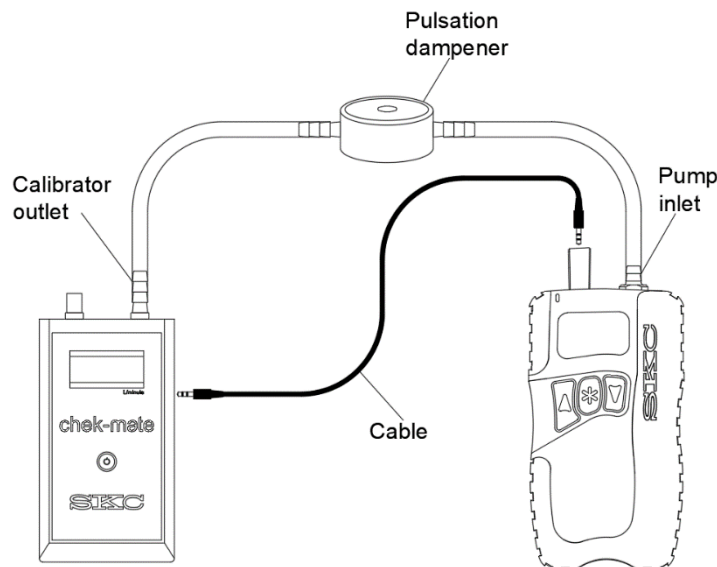

Figure 4. CalChek Full Calibration Train

5. Verify that the battery icon on the pump display shows at least two bars. If it does not, charge the battery before proceeding.
6. Press ▲ on the pump keypad seven times to place pump in full calibration mode.
7. When airflow through the chek-mate is detected, it will automatically produce its flow rate reading via the CalChek serial interface at 3.5-second intervals. The pump will display FCAL, CS1, and a brief flow rate. The pump will continue to display CS2, then a flow rate, CS3, then a flow rate, etc., until calibration is completed at all flow rates between 5 and 15 L/min.



 **To abort CalChek full calibration, press [▲▼]. The pump will go into Hold.**

8. CCAL will display during Calibration Check mode and will count down to one. The pump will stop running.
9. When calibration is completed, the pump will go to Hold. If the calibration was successful, the pump LCD will revert to displaying pump run time as 0.0. If there was failure during the calibration process, an error code of E4[x] will appear. See *CalChek Error Chart in Troubleshooting*.

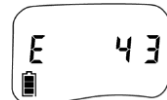

 **To remove a CalChek error code from the LCD, press *.**

10. Allow the pump to go to Sleep mode to write calibration data to pump memory.

CalChek Full Calibration Data (Requires DataTrac for Leland Legacy Software)

Full calibration completely clears pump history, run time parameters, and the DataTrac Scheduler. Full calibration data can be viewed and printed by going to the DataTrac Pump Manager window in DataTrac for Leland Legacy Software and clicking on the View menu. Choose Calibration Info. This will display calibration results, pump serial number, and date of the last full calibration. A button allows this data to be printed. The printed report contains pump version, date printed, and a validation code to perform data verification.

CalChek Full Calibration Data Verification (Requires DataTrac for Leland Legacy Software)

To ensure that printed calibration data has not been tampered with, pull down the Tools menu in the Calibration Info window and choose Confirm Validation Code. Enter the data from the printed report, including the validation code. DataTrac Software will indicate whether the information is completely valid or if a parameter has been changed. **Note:** *When entering data to confirm the validation number, enter the date in the following format: mmm dd, yyyy (e.g., Aug 18, 2021).*

TROUBLESHOOTING

CalChek Error Chart

Single-point Calibration Errors

Error	Problem	Troubleshooting
E41	Correction required too large. A gross mismatch between the flow setting on the pump and the reading generated by the calibrator has occurred.	Perform a full calibration. If this fails, contact SKC TechnicalSupport at skctech@skcinc.com.
E48	Could not get a successful single-point calibration within five flow readings.	Try the calibration again. If problem persists, perform a fullcalibration.

Multiple-point (Full) Calibration Errors

Error	Problem	Troubleshooting
E44	First flow reading greater than 5 L/min. The pump is flowing faster than it should, even though the calibration routine delivered only a very small voltage to the pump.	Check pressure sensor tubing to ensure that it is not pinched or blocked or contact SKC Technical Support at skctech@skcinc.com.
E45	Pump unable to achieve flow rate of 15 L/min possibly due to a blocked inlet filter or flow tube or an air leak inside the pump.	Check pump inlet filter for debris and flow tube for blockage or contact SKC Technical Support at skctech@skcinc.com.
E46 or E49	Analysis error in the data (rare)	Try full calibration again. If problem persists, contact SKC Technical Support at skctech@skcinc.com.
E47	Less than two bars appear in the battery icon on the pump display, indicating that the battery is too low. There must be at least two bars showing to begin a full calibration.	Recharge the battery.
—	At conclusion of full calibration, pump does not verify to within 5%.	Pump not at ambient conditions for at least two hours. Retrycalibration after pump has been at ambient conditions for two hours. Pump not running for five minutes prior to calibration. Run pump for five minutes and retry calibration.

Errors That Can Occur During Both Calibration Modes

Error	Problem	Troubleshooting
E42	Unstable average. There is too much variation in the flow readings.	Try the calibration again. If problem persists, contact SKC Technical Support at skctech@skcinc.com.
E43	Serial time out. The calibrator is not communicating with the pump.	Check adapter connection. If loose or disconnected, connect properly.
E4A	Calibration has been initiated before pump has equilibrated.	Press *. Allow pump to run until “no” disappears from display. If problem persists, contact SKC Technical Support at skctech@skcinc.com.

ACCESSORIES/REPLACEMENT PARTS

Accessories

Cat. No.

CalChek Communication Cable, for use with High Flow chek-mate Calibrator with CalChek, *required for automatic calibration of Leland Legacy Sample Pump* 375-200

Chargers

Single Charging Kit, 100-240 V AC, 50/60 Hz, includes charging unit, power supply, and interchangeable wall plugs 223-241

Take Charge 5 Multi-charger, for Leland Legacy and AirChek XR5000 Li-Ion model pumps, includes charging unit and power cable, 100-240 V AC 223-441

High Flow chek-mate Calibrator with CalChek, 5 to 30 L/min, includes a 9-volt alkaline battery

with NIST standard traceable calibration certificate 375-50300N

with UK standard traceable calibration certificate 375-50300

with ISO standard traceable calibration certificate 375-50300S

Pulsation Dampener, *required for use with High Flow chek-mate Calibrator for calibration of high flow pumps and CalChek calibration of Leland Legacy pump* 375-150

Kit with High Flow chek-mate Calibrator and Pulsation Dampener Cat. No. 375-150
with NIST standard traceable calibration certificate 375-50300-KN
with ISO standard traceable calibration certificate 375-50300-KNS

Battery Charging Adapter, for charging batteries outside the pump 223-248

Single Kit Case, Pelican, with foam 224-912

Noise-reducing Pouch, Nylon, black, lined to reduce pump noise from 62.5 to 52 dBA,[†] includes waist belt and shoulder strap 224-89

DataTrac Software Cable, for Leland Legacy, USB; *software available via free download from www.skinc.com* 877-92

Tubing Adapter, adapts 3/8-inch ID tubing to 1/4-inch ID tubing P31211

[†] Measured 1 meter from pump operating at 10 L/min and 12 inches water back pressure

Replacement Parts	Cat No.
Battery pack, Li-Ion*	P75692A
Filter/O-ring Set, 5 filters and 1 O-ring	P40021B
Inlet Filters, pk/50	P40021A
DataTrac Cable	P22103B

* *Li-Ion batteries are subject to special shipping regulations.*



Use only SKC-approved parts to ensure reliable performance. Failure to do so voids any warranty.



Use of a repaired or rebuilt battery pack VOIDS ANY WARRANTY.

Li-Ion Battery Testing and Shipment

Rechargeable lithium-ion batteries for use with SKC sample pumps have been tested in accordance with the UN Manual and are proven to meet requirements of each test in the UN Manual of Tests and Criteria, Part III, subsection 38.3. The batteries are rated below 100 watt-hours (Wh).

Consult with your carrier for more information on Lithium Battery Shipping Regulations UN3480 and UN3481 or visit www.skcinc.com/knowledgecenter for more information.

SKC Limited Warranty and Return Policy

SKC products are subject to the SKC Limited Warranty and Return Policy, which provides SKC's sole liability and the buyer's exclusive remedy. To view the complete SKC Limited Warranty and Return Policy, go to skcinc.com/warranty.

APPENDIX: PERFORMANCE PROFILE

Flow						
Flow Range	5 to 15 L/min					
Flow Control System	Closed loop with internal flow sensor					
Compensation Range	15 L/min at 5 inches water back pressure 10 L/min at 12 inches water back pressure 5 L/min at 20 inches water back pressure					
Typical Back Pressure of Sampling Media <i>(inches water)</i>	Flow Rate (L/min)	5	8	10	12	15
	Filter/Pore Size (µm)					
	37-mm MCE/0.8	11	18	22	28	36
	37-mm PVC/5.0	4	7	9	11	15
	<i>Compare the information in this table to pump compensation range to determine appropriate applications.</i>					
Accuracy	Flow Rate: ± 5% of set-point after calibration to desired flow Timing: 1 min/month at 25 C Atmospheric Pressure: ± 0.3 in Hg					
Flow Fault	If the pump is unable to compensate for > 15 seconds due to excessive back pressure, a flow fault icon displays and flashes, the pump enters Hold mode, and the pump retains historical data. Auto-restart is attempted every 20 seconds up to 10 times. <i>Adjustable with DataTrac for Leland Legacy Software. See Flow Fault under Sampling Functions and Program the Pump Using a PC.</i>					
Flow Control	An internal isothermal flow sensor measures flow directly and continuously. Sensor readings are used in a flow monitoring algorithm to maintain calibrated volumetric flow. In addition, built-in atmospheric temperature and pressure sensors provide readings to correct volumetric flow for these parameters when they vary from point of calibration.					
Tubing	<i>Requires 3/8-in ID tubing</i>					
Operating						
Display	LCD displays pump serial number, pump software revision level, flow rate, volume, temperature, atmospheric pressure, time of day, run time, and pump status, i.e., Hold and run as well as Setup information.					
Volume Display	Continually updated, based on corrected flow rate multiplied by sampling time. When volume exceeds 99,999 liters, the pump will continue to run normally but an O_FIO Error will appear on the LCD.					
Time Display	Time of day in hrs and min (12 or 24-hr clock) with AM and PM indicators					
Timer Display Range	1 to 99,999 minutes (69 days). If the run time exceeds 69 days, the timer display rolls over.					
Operating Temperature	32 to 104 F (0 to 40 C)					
Altitude	The pump can apply correction to volumetric flow during sampling for weather-related or altitude variations from the atmospheric pressure established at calibration up to at least 7500 feet (2286 meters) above and 5000 feet (1524 meters) below sea level.					
Operating Humidity	0 to 95% non-condensing					
Typical Run Time†	<ul style="list-style-type: none"> • Sioutas Impactor (approx. 13 inches water back pressure): 24 hrs at 9 L/min • IMPACT Sampler: 24 hrs at 10 L/min • Low-volume PUF Tube: 24 hrs at 5 L/min • DPS Sampler (PM2.5 or PM10): 24 hrs at 10 L/min • 8 L/min Respirable PPI: 24 hrs at 8 L/min • For extended run times, pump may be operated while attached to approved charger. 					
Noise Level	62.5 dBA - pump without case 52 dBA - pump housed in noise-reducing case <i>(optional accessory Cat. No. 224-89, see Accessories)</i> <i>Measured 3 ft (1 m) from pump operating at 10 L/min and 12 inches water back pressure</i>					
User-adjustable Values	Sample run time, calibration, clock display, flow rate, time of day, delayed start, and temperature and atmospheric pressure display					
Recorded Values	Start date and time, stop date and time, total sample time, flow rate, sample volume, temperature, atmospheric pressure, and pump mode transitions					
Adjustable Logging Interval	Records pump history from 3 sec (15.4 min of data) up to 8 hrs (over 102 days of data) depending on setting. <i>Option available when using DataTrac Software.</i>					

Power	
Power Supply	<ul style="list-style-type: none"> • Battery: Removable, rechargeable lithium-ion (Li-Ion), 7.4 V, 10.4-Ah capacity, 77 Wh • Charger/AC adapter: Input voltage 100 - 240 V AC
Battery Recharge Time <i>(with SKC-approved chargers; varies with battery capacity and level of discharge)</i>	15 hrs
Charging Temperature	32 to 113 F (0 to 45 C)
Storage Temperature	-4 to 95 F (-20 to 35 C)
Physical	
Size	8 x 3.9 x 2.6 in (20 x 10 x 7 cm)
Weight	36 oz (1 kg)
Case	Thermoplastic with soft rubber overmolding
RFI/EMI Shielding	CE marked
Approvals	Leland Legacy with Sioutas Impactor performance has been verified by EPA-ETV.

† Results when tested with a new pump and new fully charged battery. Pump performance may vary.